

KLIMA-FLEX 1-HANDTAG, SYRAFAST



Industrilås Klim-flex™ 1-handtag tillverkat av syrafast stål 316. Passar alla låsningsenheter i Klima-flex 1-serien.



MATERIAL

Handtag: Rostfritt stål 316

RELATERADE PRODUKTER

Latching units: 2-311ab, 2-311cd, 2-316a, 2-316b

Safety catches: 2-314

Needed components for a complete system:
2-311ef

Use the Index Code at industrilas.com

TESTS & STANDARDS

Standarder: VDI 6022

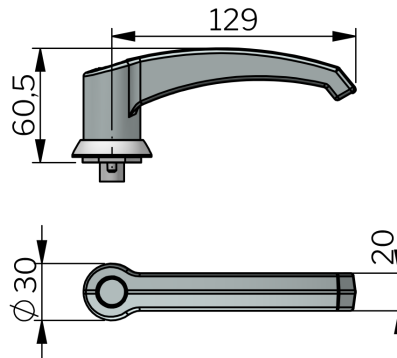

Industrilås
— When access counts —

Artikelnummer

Beskrivning

269076-00

Non-locking K1 handle, stainless steel 316

Index Code: 2-311ef

PRINT DATE: 2024-04-26@12:48